



OWNER'S MANUAL



WARNING

- For safety reasons, please read the manual first before plugging in machine.
- Please keep this manual properly for convenient reference as needed.

Safety Introduction – Read before operating

This manual is intended to provide detailed descriptions together with all necessary information covering the general

operation of electronic assemblies, electromechanical, servicing control, spare parts, etc. for the product:

Hot Racers

This manual is intended for the owners, personnel managers in charge of operation of this product.

Operate the product after carefully reading and sufficiently understanding the instructions.

In the unlikely event that the product does not function correctly, **DO NOT** allow anyone other than a technician to touch the internal system. Turn off the power to the machine, making sure to unplug the electrical cord from the outlet, and contact the office listed below or the point-of-purchase for this product.

Use of this product is unlikely to cause physical injuries or damage to property. However, points that require special attention are indicated on the game cabinet in the form of warning labels.

Warning: Proceed with caution – Only open door/cover if you are a qualified technician

High voltage can cause an electric shock

Turn off before servicing



Danger: Potential immediate danger

High voltage can cause an electric shock

Turn off before servicing

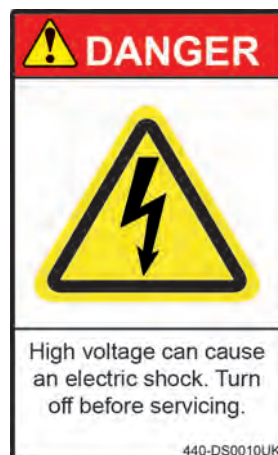

Potential Risk to life or damage to product

If ignored, may result in the mishandling of the product and cause faulty operation or damage to the product or person(s)

Definition of 'Site Maintenance Personnel' or Other Qualified individuals.

STOP IMPORTANT

Procedures not described in this manual or marked as 'to be carried out by site maintenance personnel or other qualified professionals should not be carried out by personnel without the necessary skill or technological experience. Work carried out by unqualified persons may cause serious accidents, including electrocution.

Parts replacement, maintenance inspections and troubleshooting should be carried out by site maintenance personnel or other qualified professionals. This manual includes directions for potentially dangerous procedures which should only be carried out by professionals with the appropriate specialised knowledge.

The site maintenance personnel or other qualified professionals mentioned in this manual are defined as follows:

Site maintenance personnel:

Individuals with experience in maintaining amusement equipment, vending machines, etc., working under the supervision of the owner/operator of this product to maintain machines within amusement facilities or similar premises by carrying out everyday procedures such as assembly, maintenance inspections, and replacement of units/expendable parts.

Activities to be carried out by site maintenance personnel:

Amusement equipment/vending machine assembly, maintenance inspection and replacement of units/expendable parts.

Other qualified professionals:

Persons employed by amusement equipment manufacturers, or involved in design, production, testing or maintenance of amusement equipment. The individual should have either graduated from technical school or hold similar qualifications in electrical/electronic/mechanical engineering.

Activities to be carried out by other qualified professionals:

Amusement equipment/vending machine assembly, repair/adjustment of electrical/electronic/mechanical parts.

BEFORE USING THE PRODUCT, BE SURE TO READ THE FOLLOWING:

To maintain safety:

To ensure the safe operation of this product, be sure to read the following before usage:

The following instructions are intended for the users, operators and the personnel in charge of the operation of the product. After carefully reading and sufficiently understanding the warning displays and cautions, handle the product

appropriately. Be sure to keep this manual close to the product or in a convenient place for future reference.

- **Perform work in accordance with the instructions herein stated.** Instructions for work are explained by paying attention to the aspect of accident prevention. Failing to perform work as per the instructions can cause accidents. In the case where only those who have technical expertise should perform the work to avoid hazardous situation, the instructions herein state that the site maintenance personnel should perform such work.
- **Be sure to turn off the power before working on the machine.** To prevent an electric shock, be sure to turn off the power before carrying out any work that requires direct contact with the interior of the product. If the work is to be performed in the power-on status, the Instruction Manual herein always states to that effect.
- **Be sure to ground the Earth Terminal** (This is not required in the case where a power cord with earth is used).
- **This product is equipped with the Earth Terminal.** When installing the product, connect the Earth Terminal to the "accurately grounded indoor earth terminal" by using an earth wire. Unless the product is grounded appropriately, the user can be subject to an electric shock. After performing repair, etc. for the control equipment ensure that the Earth Wire is firmly connected to the control equipment.
- **Ensure that the Power Supply used is equipped with an Earth Leakage Breaker.** This product does not incorporate the Earth Leakage Breaker. Using a power supply which is not equipped with the Earth Leakage Breaker can cause a fire when earth leakage occurs.
- **Be sure to use fuses which meet the specified rating** (only for the machines which use fuses). Using fuses exceeding the specified rating can cause a fire and an electric shock (only for the machines which use fuses). Using fuses exceeding the specified rating can cause a fire and an electric shock.

Specification changes (removal of equipment, conversion and/or addition) not designated by SEGA are not allowed. The parts of the product include warning labels for safety, covers for personal protection, etc. It is hazardous to operate the product by removing parts and/or modifying the circuits. Should doors, lids and protective parts be damaged or lost, refrain from operating the product, and contact where the product was purchased from or the office herein stated. SEGA shall not be held responsible for any accidents, compensation for damage to a third party, resulting from the specifications not designated by SEGA.

- **Ensure that the product meets the requirements of appropriate electrical specifications.** Before installing the product check for electrical specifications. SEGA products have a nameplate on which electrical specifications are described. Ensure that the product is compatible with the power supply voltage and frequency requirements of the location. Using any electrical specifications different from the designated specifications can cause a fire and an electric shock.

- **Install and operate the product in places where appropriate lighting is available, allowing warning labels to be clearly read.** To ensure safety for the customers, labels and printed instructions describing potentially hazardous situations are applied to places where accidents can be caused. Ensure that where the product is operated has sufficient lighting allowing the warnings to be read. If any label is peeled off, apply it again immediately. Please place an order with where the product was purchased from or the office herein stated.

- **When transporting or reselling this product, be sure to attach this manual to the product.**

- *Descriptions herein contained may be subject to improvement changes without notice.*

- *The contents described herein are fully prepared with due care. However, should any question arise, or errors be found, please contact SEGA.*

INSPECTIONS IMMEDIATELY AFTER TRANSPORTING THE PRODUCT TO THE LOCATION

Normally, at the time of shipment, SEGA products are in a status allowing for usage immediately after transporting to the location. Nevertheless, an irregular situation may occur during transportation. Before turning on the power, check the following points to ensure that the product has been transported in a satisfactory status.

- Are there any dented portions or defects (cuts, etc.) on the external surfaces of the cabinet?
- Are casters and adjusters damaged?
- Do the power supply voltage and frequency requirements meet with those of the location?
- Are all wiring connectors correctly and securely connected? Unless connected in the correct way, connector connections cannot be made accurately. Do not insert connectors forcibly.
- Do power cables have cuts and dents?
- Are all accessories available?
- Can all doors and lids be opened with the accessory keys? Can doors and lids be firmly closed?

INTRODUCTION

Thank you for choosing SEA Animation Technology's double-screen racing game hot racers. It's a racing game mainly for children, but also for parents to play with their children. With high recognition, classic police theme and interesting big eyes in demo mode. You can choose ticket, capsule or play for fun game modes.

TABLE OF CONTENTS

PRODUCT SPECIFICATION-----	1
INSTALLATION-----	2,3
PART DESCRIPTIONS-----	4
CAUTION & WARNING STICKERS-----	5
SETTINGS & OPTIONS-----	6,7
BOOKKEEPING-----	8
INPUT / OUTPUT TESTS-----	8
ERROR CODES-----	8
CONTROLLER MECHANISM-----	9
SPARE PARTS-----	9
WIRING DIAGRAM-----	10
DESIGN RELATED PARTS-----	11

PRODUCT SPECIFICATION

■ Location	Indoor Only
■ Dimension	1700(W)X1500(D)X2080(H) mm
■ Rated Voltage、Frequency	AC220V 50HZ /60HZ
	AC110V 50HZ /60HZ
■ Power Consumption	370W
■ Weight	150kg

* 110V voltage can be set through the power supply. Please contact the distributor for details.

NOTE: The contents herein described are subject to change without notice.

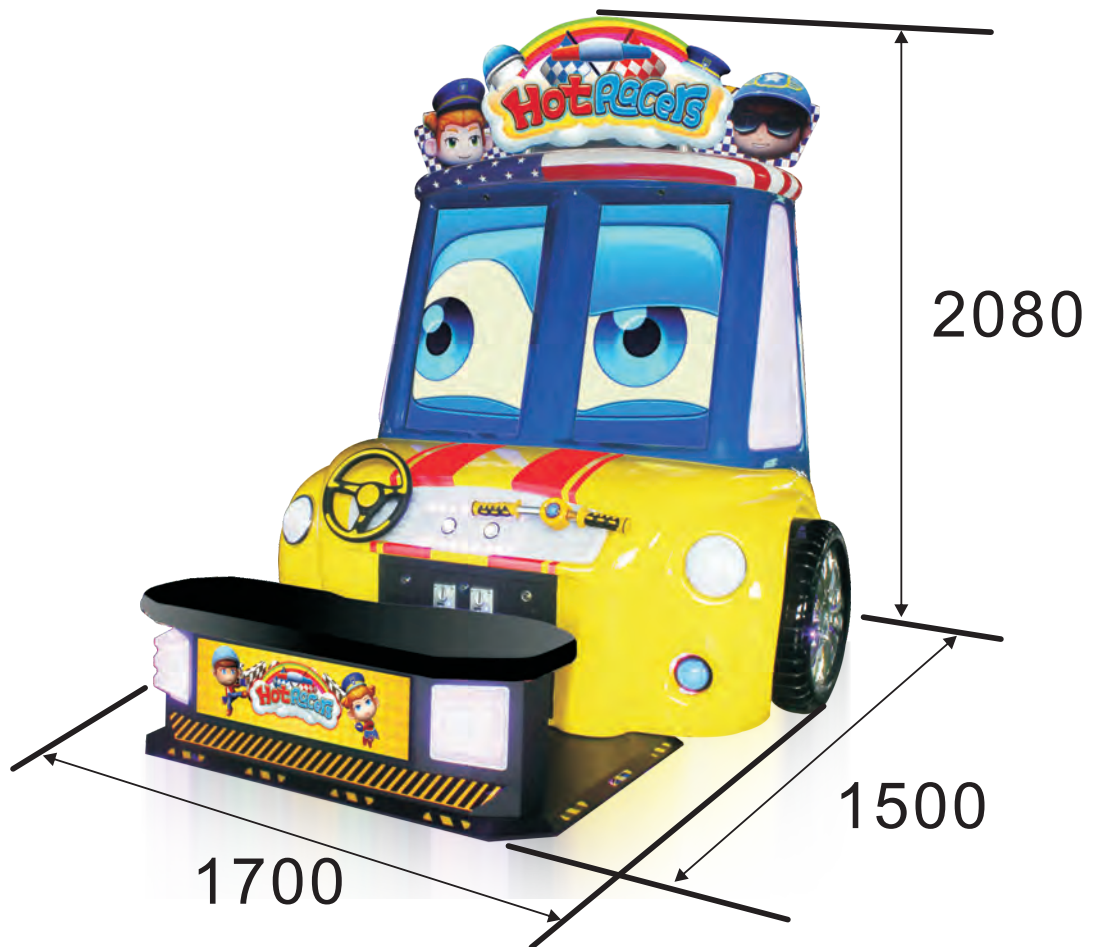

INSTALLATION

Installation complete



Installation accessories



parts



lift



Lift main cabinet to locate floor hole

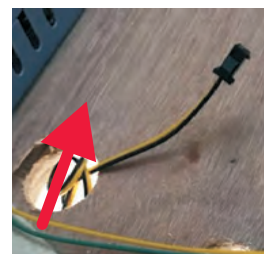

Pass Seat LED harness through floor hole



Connect harness



Pass floor bolt through cabinet hole

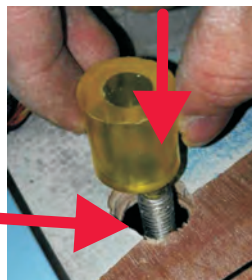

Fit rubber bush

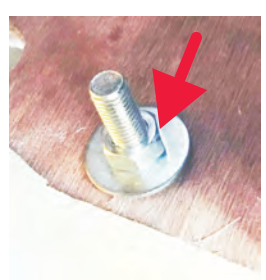

Fit the lock nut

INSTALLATION



Open access door



Remove screws from back door that hold the light box

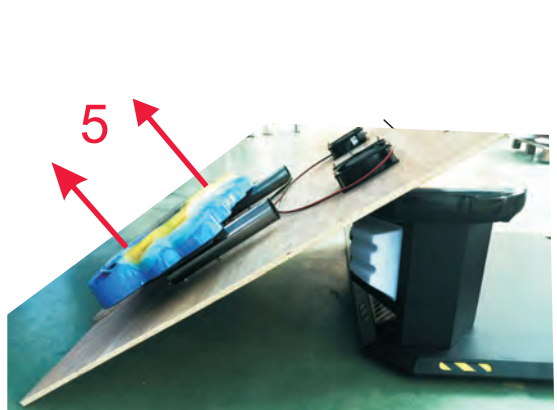

Remove the light box from the door



parts

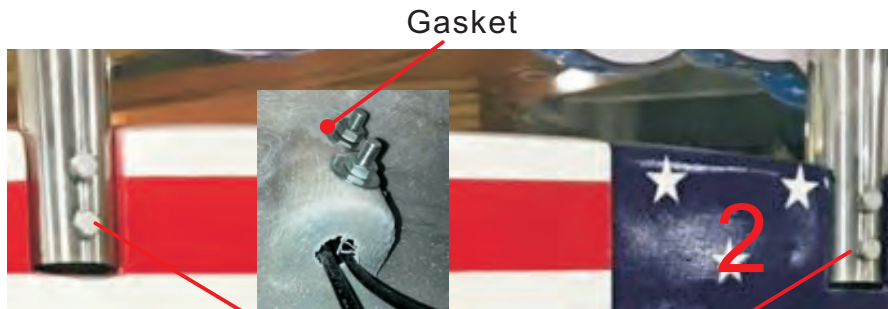

Gasket

Install light box



Pass wires from light box into cabinet

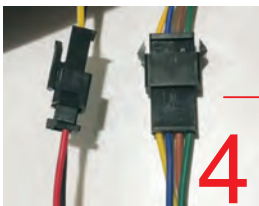

Connect light box wire harnesses

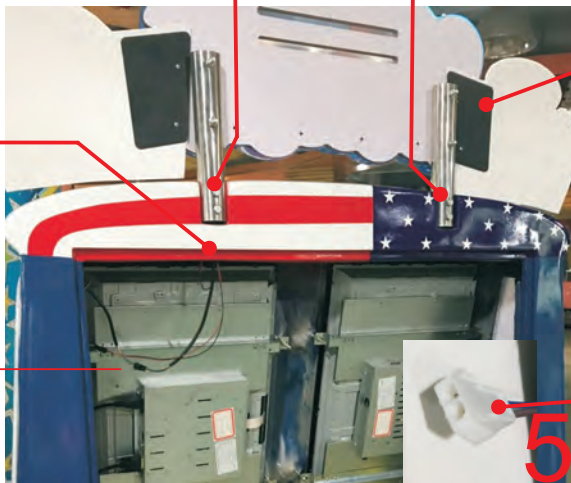

Fit left & right character heads to light box



Connect fan wire harness

PARTS NAME

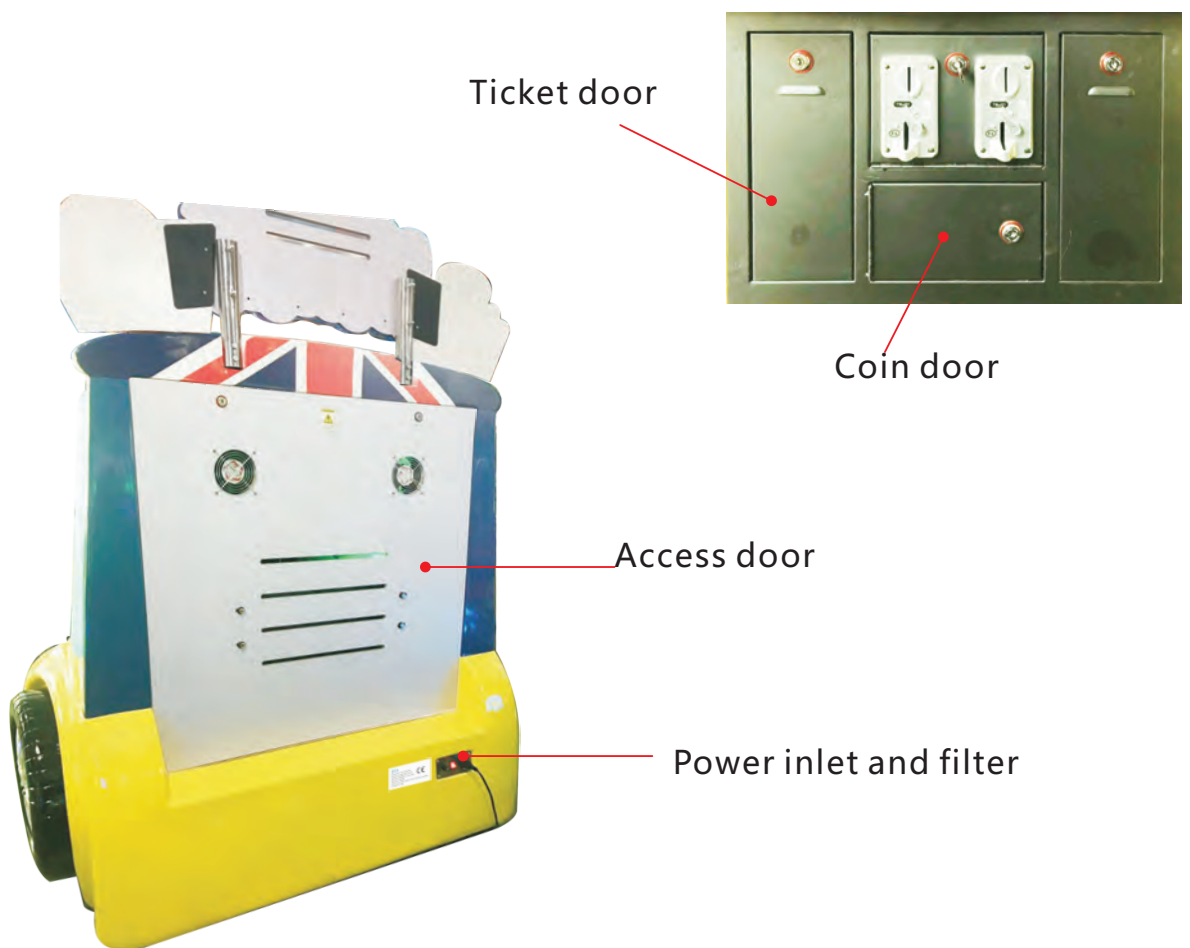
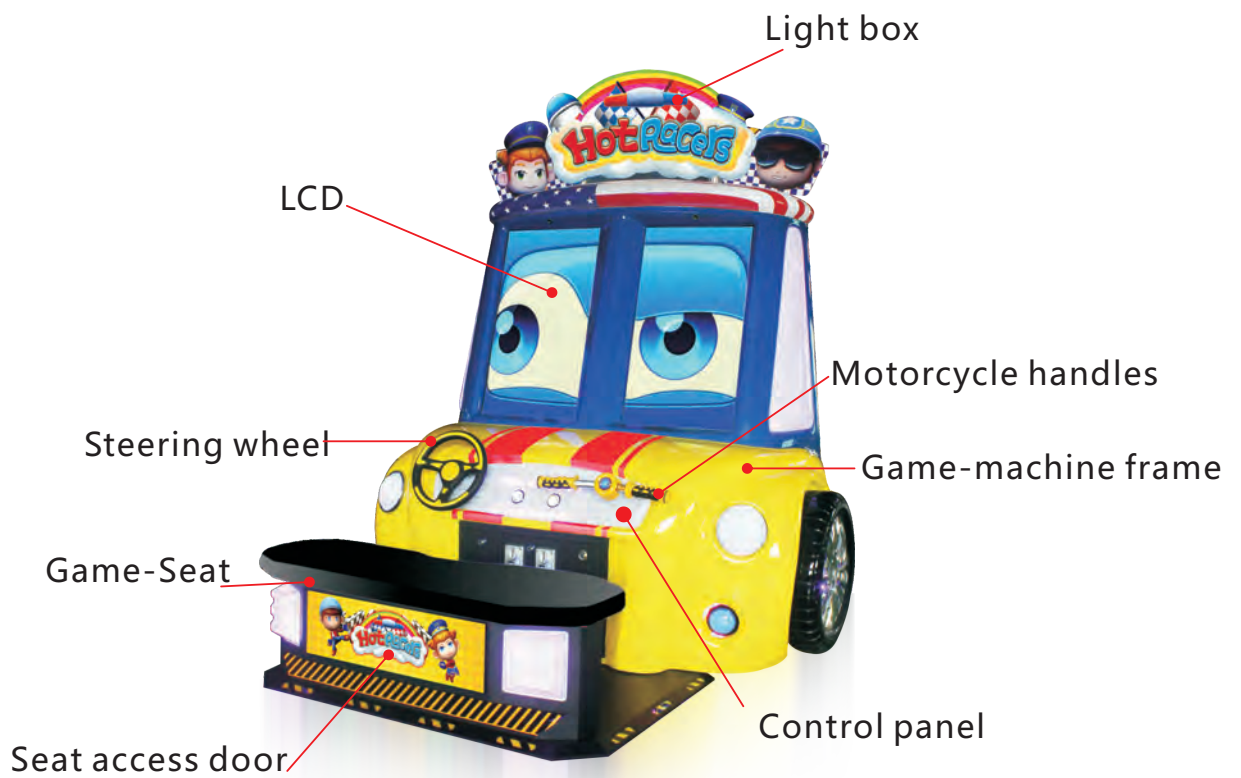

CAUTION & WARNING STICKERS



3A



SEA

PRODUCT: HOT RACERS
 MODEL NUMBER: SEA-08
 SERIAL NUMBER: HTR-1001
 WEIGHT: 400KG
 VOLATGE / FREQUENCY: 220-240VAC @ 60Hz
 POWER: 370W

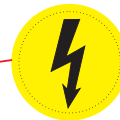
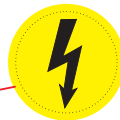
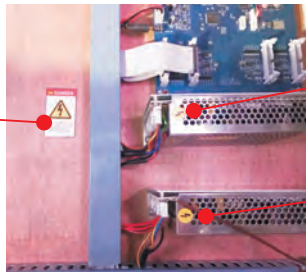
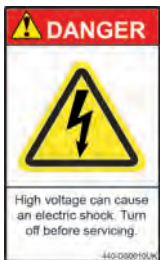
SETTINGS & OPTIONS



▲Up and ▼down buttons can directly adjust the game volume in the game interface. Press “ENTER” to enter the background debugging interface



---Settings---

Ver.080318

➔ **Play for Fun** Choose the mode of operation.
 Ticket Mode Options n.b. if you change to a different option, the
 Capsule mode bookkeeping data and previous settings will be
 erased and return to default

Demo Sound 100 ---Set level for demo sound

Auto Play Time OFF ---Use this option to change the time for auto select of game and level. can be turned off so player can choose with the start button

Bookkeeping -----Check accounts for tickets paid and coins in

IO Test -----Test all io functions

Exit -----Go back to last page

---Play for Fun---

➔ **Coins to play 2** -----Set number of coins/pulses to start a game

***Game Time 150** -----Set length of each game (seconds)

Boss entry time 60 ---Set to time the boss will enter the game. only for single player mode

***Boss Health 12** -----Set the number of hits the player needs to defeat the boss

***Boss complete points 200** -----Number of points the player achieves when beating the boss

Link play wait time 10 -----Set the time given to the player to select a link play game (2 player)

Choose Time 10 -----Set the time given to the player to select a level

***Victory continue 4** -----Set the continue option (1= no continue, 2= 1 free game if beat boss, 3= 2 free game if beat boss, 4 = 3 free games if beat boss)

***Car Speed 10** -----Set the speed of the car

Reset to default ----- Restore all game settings to factory settings

Exit -----Go back to last page

SETTINGS & OPTIONS

-Ticket Mode Options--

➔ Coins to play	2	-----Set number of coins/pulses to start a game
*Game Time	150	-----Set length of each game
Boss entry time	60	----Set to time the boss will enter the game. only for single player mode
*Boss Health	12	-----Set the number of hits the player needs to defeat the boss
*Boss complete points	200	-----Number of points the player achieves when beating the boss
Link play wait time	10	-----Set the time given to the player to select a link play game (2 player)
Choose Time	10	-----Set the time given to the player to select a level
*Victory continue	1	----Set the continue option (1 = no continue, 2 = 1 free game if beat boss, 3 = 2 free game if beat boss, 4 = 3 free games if beat boss)
*Car Speed	10	-----Set the speed of the car
Ticket Score	50	-----Set the number of points required to win 1 ticket
Champion Bonus	5	-----Number of tickets achieved by the winner in 2 player mode if championship score is reached
Champion Score	500	----- Score for player to reach to win championship bonus tickets
Min Ticket	3	----- Mercy ticket option. if a player does not achieve a score high enough for any tickets
Max Ticket	50	----Max amount of tickets paid regardless of score or other ticket settings
Reset to default		----- Restore all game settings to factory settings
Exit		-----Go back to last page

---Capsule mode---

➔ Coins to play	2	-----Set number of coins/pulses to start a game
*Game Time	150	----Set length of each game
Boss entry time	60	----Set to time the boss will enter the game. only for single player mode
*Boss Health	12	-----Set the number of hits the player needs to defeat the boss
*Boss complete points	200	-----Number of points the player achieves when beating the boss
Link play wait time	10	-----Set the time given to the player to select a link play game (2 player)
Choose Time	10	-----Set the time given to the player to select a level
*Victory continue	1	----Set the continue option (1 = no continue, 2 = 1 free game if beat boss, 3 = 2 free game if beat boss, 4 = 3 free games if beat boss)
*Car Speed	10	-----Set the speed of the car
Gift Score	500	-----Set the number of points required to win 1 gift
Champion Bonus	1	-----Number of gifts won by the winner in 2 player mode if championship score is reached
Champion Score	500	----- Score for player to reach to win championship bonus gifts
Min Gift	Unlimited	---- Mercy gift option. if a player does not achieve a score high enough for any gift (wet mode)
Max Gift	5	----Max amount of gifts paid regardless of score or other settings
Reset to default		----- Restore all game settings to factory settings
Exit		-----Go back to last page

BOOKKEEPING

---Bookkeeping---

Current Coins:0
 Current Tickets:0
 Current Gifts:0
 Total Coins:0
 Total Tickets:0
 Total Gifts:0

- ➔ Empty Coins --- Clear current credits on game
- Empty Tickets --- Clear owed tickets
- Empty Gifts --- Clear owed gifts
- Empty Rankings --- Clear all ranking data (leaderboard)
- Empty Current Data --- Clear all accounting data (tickets, coins, gifts)
- Empty Total Data --- Clear all data
- Exit --- Go back to last page

INPUT/OUTPUT TESTS

---IO Test---

Operate game hardware to check input response to io system

P1Coin P2Coin
 P1OK P2OK
 P1_L P2_L
 P1_R P2_R

 P1Tickets:0
 P1Gifts:0
 P2Tickets:0
 P2Gifts:0
 ➔ P1Ticket 1 P2Ticket 1
 P1Gift 1 P2Gift 1
 Exit

Select output device to test

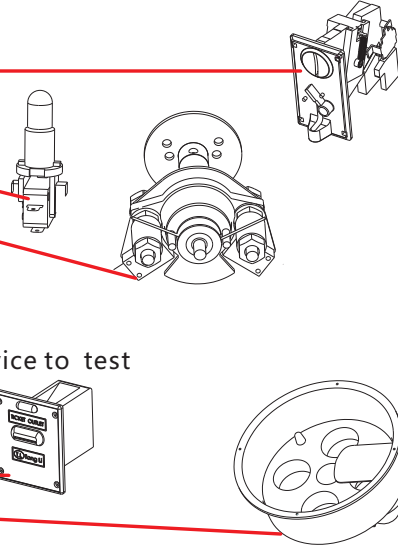

ERROR CODES

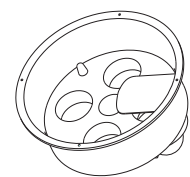
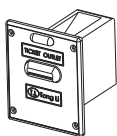
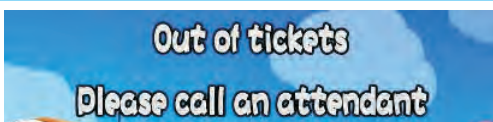





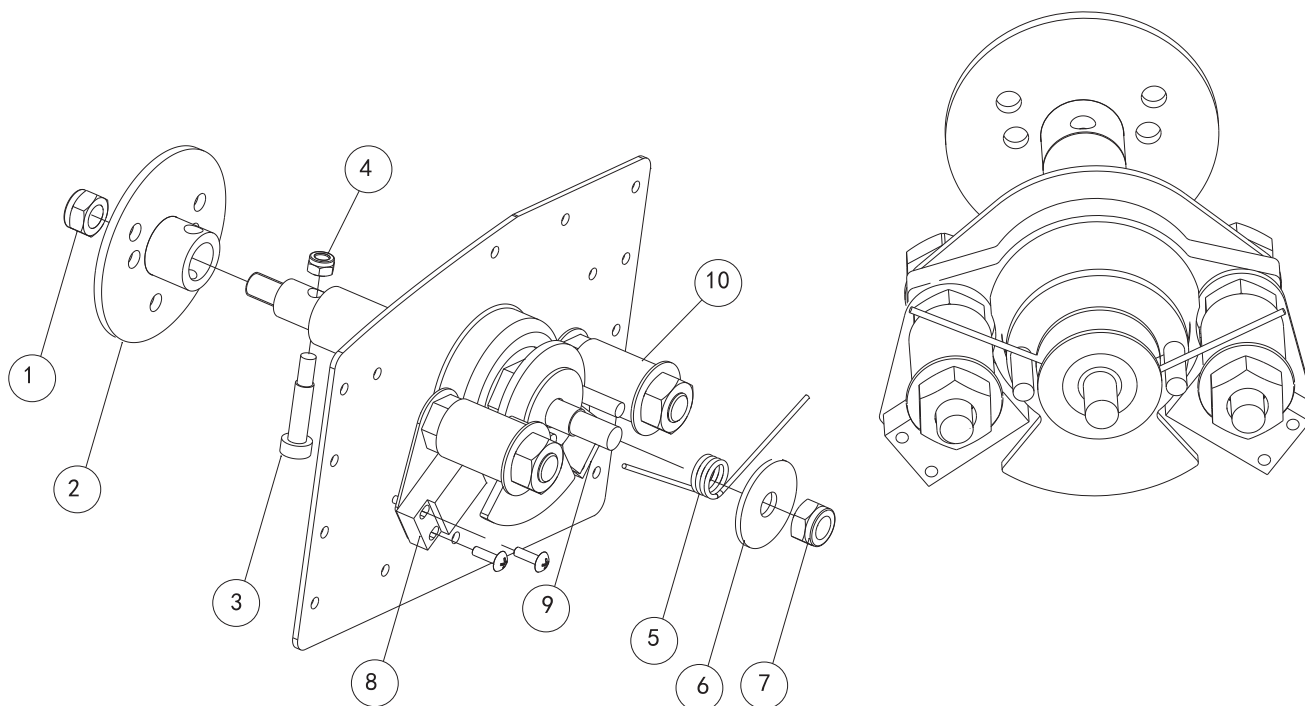

Out of tickets / gifts will be displayed on screen when it is out or malfunction with the dispenser has occurred, the top header LEDs will also flash to denote an error

CONTROLLER MECHANISM



number	name	number	name
1	locknut M8	6	shim M8
2	cutting ferrule	7	locknut M8
3	bolt	8	inductor 1
4	locknut M6	9	inductor 2
5	spring	10	Polyurethane

Spare parts

HR-01 steering wheel sensor		2	HR-04 lock		1
HR-02 steering spring		4	HR-05 Warning plastic		3
HR-03 start button		2	HR-06 fuse-3A		3

WIRING DIAGRAM

Machine Name: hotracers



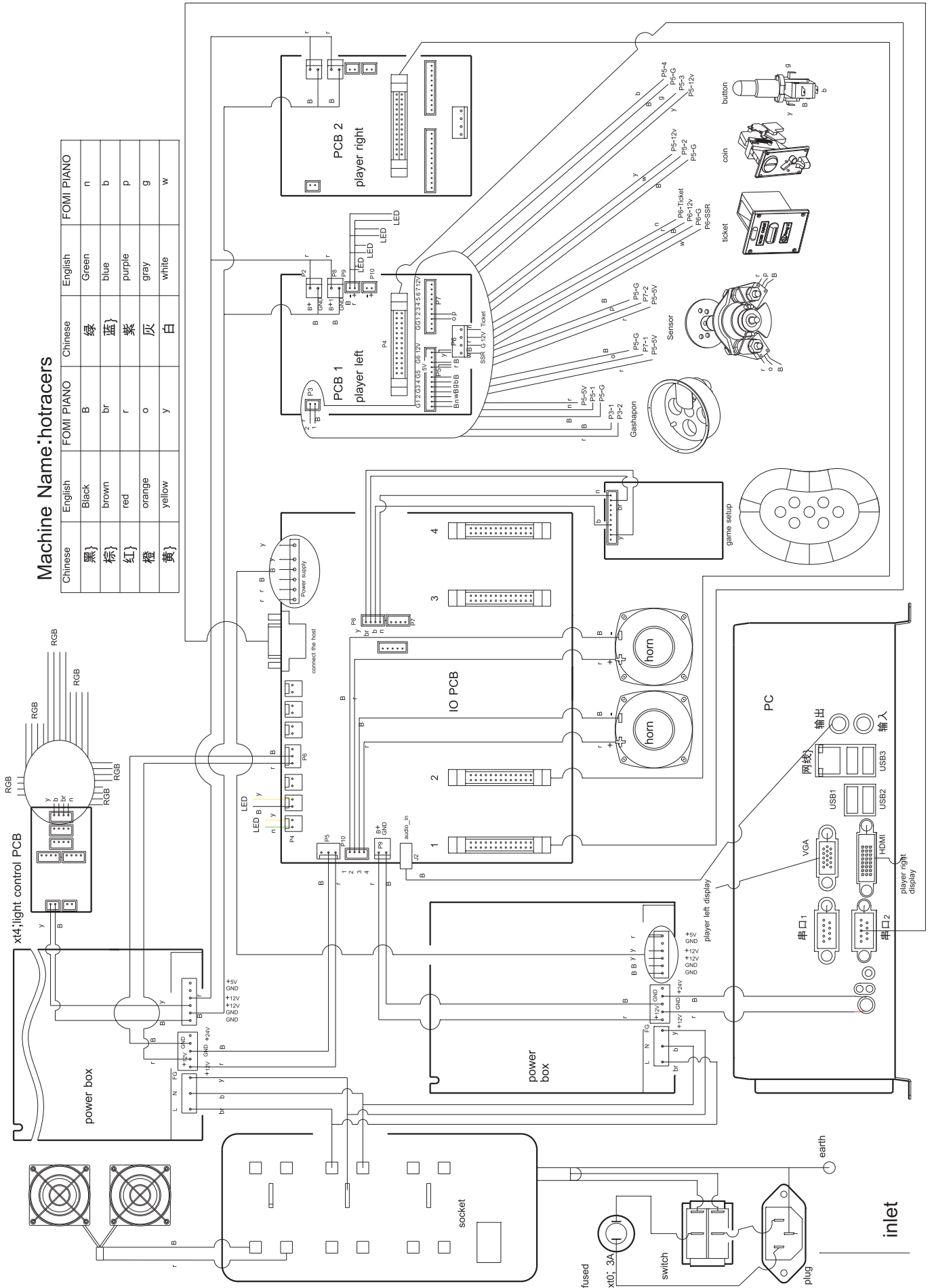





Chinese	English	FOMI PIANO	Chinese	English	FOMI PIANO
黑}	Black	B	绿	Green	n
棕}	brown	br	蓝	blue	b
红}	red	r	紫	purple	p
橙	orange	o	灰	gray	g
黄}	yellow	y	白	white	w





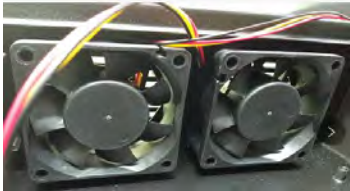

PRINTING PATTERN



Spare parts lists

Part NO.	Parts name	pictures
HR-01	steering wheel sensor	
HR-02	steering spring	
HR-03	start button & Switch	
HR-04	lock	
HR-06	Bike handle grips	
HR-07	power supply	
HR-08	PC Fan	
HR-09	IO board	

HR-10	computer	
HR-11	screen	
HR-12	seat cover	
HR-13	steering wheel Column (the car)	
HR-14	steering wheel Column (the bike)	

SPARES AND SERVICE CONTACT INFORMATION

- SEGA TOTAL SOLUTIONS -

42 Barwell Business Park
Leatherhead Road,
Chessington,
Surrey,
KT9 2NY
United Kingdom

Parts/Customer Service : +44 (0) 208 391 8060
Technical Support : +44 (0) 208 391 8072



- PLAY IT AMUSEMENTS -

870 Lively Blvd
Wood Dale,
IL,
60191
United States of America

Parts/Customer Service : +00 (1) 224 265 4287
Technical Support : +00 (1) 224 265 4283

